

# KR Series with Cree SmartCast® Technology

KR4™ LED Specification Downlight – Square 4"

## Product Description

The KR4™ LED specification downlight with Cree SmartCast® Technology, Cree's intelligent light solution, provides extreme energy productivity and code compliance – all with installation that's so intuitive and simple, it just works. The KR Series is available in a variety of color temperatures and round and square trims with high-quality anodized aluminum reflector finish.

## Performance Summary

Utilizes Cree TrueWhite® Technology

### Initial Delivered Lumens:

650-2,050 lumens; Delivered lumen output is typical when using a SSGC type reflector

**Input Power:** 13-39 watts

**Emergency Performance:** Up to 1,210 Lumens; 10W; Minimum 90 Minutes

**CRI:** 90

**CCT:** 2700K, 3000K, 3500K, 4000K

**Controls:** Cree SmartCast® Technology

**Limited Warranty:** 10 years on luminaire/5 years on SmartCast Technology module

**Limited Warranty Emergency Back Up (EB) Battery:** 1 Year Battery Back Up. Test regularly in accordance with local codes

\*See <http://lighting.cree.com/warranty> for warranty terms

## Accessories

Field-Installed		
<b>C-Channel Hanger Bars</b> RBH30C - Pair of 30" (762mm) rigid 3/4" x 1/2" (19mm x 13mm) C-Channel bars RBH24C-1 - Pair of 24" (610mm) x 1-1/2" (38mm) x 1/2" (13mm) standard C-Channel bars	<b>T-Bar Clips</b> RARC7 - Set of four - For use with RBH24C-1 hanger bars <b>Cree SmartCast® Technology Configuration Tool</b> CCT-CWC-1 - One required per project when CMA control is selected	<b>Cree SmartCast® Technology Face Plates</b> CFP-1-WH - Matching Cree face plate, 1-gang, white CFP-2-WH - Matching Cree face plate, 2-gang, white CFP-3-WH - Matching Cree face plate, 3-gang, white <b>Cree SmartCast® Technology Wireless Dimmer</b> CWD-CWC-WH <b>Cree SmartCast® Technology Wireless Switch</b> CWS-CWC-WH

## Ordering Information

Fully assembled luminaire is composed of two components that must be ordered separately:

Example: **Housing:** KR4S-20L-35K-120V-10R + **Reflector:** KR4TS-SSGC-FF

Reflector (Housing must be ordered separately)		
<b>KR4TS</b>		
Series	Reflector Finish	Flange Finish
KR4TS	SSGC Soft Satin Glow, Clear	FF Matches Reflector WF White Paint

Housing (Reflector must be ordered separately)										
<b>KR4</b>		<b>S</b>					<b>10R</b>			
Series	Size	Reflector	Initial Delivered Lumens	Optic	CCT	Voltage	Controls	Options		
KR	4 inch	S Square	<b>9L</b> 13W, 650 Lumens – 50 LPW <b>13L</b> 18W, 950 Lumens – 53 LPW <b>20L</b> 30W, 1,450 Lumens – 48 LPW <b>30L</b> 39W, 2,050 Lumens – 53 LPW	Blank 70° Beam Angle	<b>27K</b> 2700K <b>30K</b> 3000K <b>35K</b> 3500K <b>40K</b> 4000K	<b>120V</b> 120 Volts <b>277V</b> 277 Volts	<b>10R Cree SmartCast® Technology</b> - Includes control module and motion and ambient sensors	<b>EB7 Emergency Backup</b> - Minimum 90 minutes - 120V, 277V only - Minimum operating temperature: 0°C (32°F)		

NOTE: Price adder may apply depending on configuration

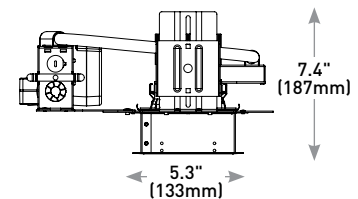
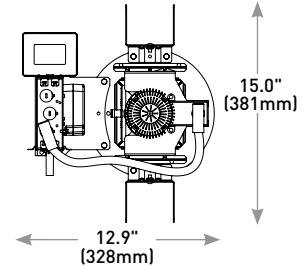

## Emergency Backup and Cree SmartCast® Technology

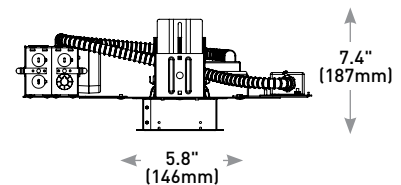
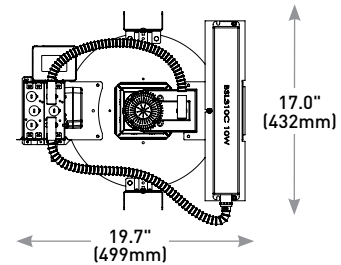

Rev. Date: V5 12/22/2016



US: [lighting.cree.com](http://lighting.cree.com)

T (800) 236-6800 F (262) 504-5415

Canada: [www.cree.com/canada](http://www.cree.com/canada)

T (800) 473-1234 F (800) 890-7507

# KR4™ LED Specification Downlight with Cree SmartCast® Technology – Square 4"

## Product Specifications

### CREE SMARTCAST® TECHNOLOGY

Cree SmartCast® Technology is the most intuitive and easiest to install intelligent light solution on the market. SmartCast Technology delivers up to 70% energy savings at up to half the cost of other solutions. Luminaires combine best-in-class light with onboard sensors and intelligence to deliver a better light experience. Extreme energy productivity, code compliance and a better light experience without any extra design, installation or setup work.

### CREE TRUEWHITE® TECHNOLOGY

A revolutionary way to generate high-quality white light, Cree TrueWhite® Technology is a patented approach that delivers an exclusive combination of 90+ CRI, beautiful light characteristics, and lifelong color consistency, all while maintaining high luminous efficacy – a true no compromise solution.

### CONSTRUCTION & MATERIAL

- Low brightness parabolic spun Alzak aluminum cone, 0.06" (2mm) thick with polished radius and continuous self-flange
- Soft Satin Glow Clear finish, standard
- 2" (51mm) aperture throat to accommodate all standard and up to 3" (76mm) thick ceilings and provide flexibility in mounting within grid
- Provided with quick mounting brackets for optional carrying channels
- Light engine, optics, and driver accessible from below ceiling

### ELECTRICAL SYSTEM

- **Power Factor:** > 0.9 for 120V and 277V
- **Total Harmonic Distortion:** < 20% at full load
- **Input Power:** 120 or 277V, 50/60Hz
- **Operating Temperature Range:** -18°C - +40°C (0°F - +104°F); minimum operating temperature with EB7 option is 0°C (32°F)

### REGULATORY & VOLUNTARY QUALIFICATIONS

- cULus Listed
- Suitable for thru-wiring 8#12AWG-90°C
- Suitable for damp locations
- Designed for indoor use
- Thermally protected Type NON-IC in accordance with Article 410 of the NEC and UL 1598
- Meets FCC Part 15, Subpart B, Class A standards for conducted and radiated emissions
- RoHS compliant. Consult factory for additional details

## Cree SmartCast® Technology

### INTEGRAL MOTION SENSOR

- Passive infrared (PIR)
- **Coverage area:** 100 sq. ft. (30.5m<sup>2</sup>) at 10 ft. (3.0m) mounting height
- Not intended to be mounted higher than 12 ft. (3.7m)
- **Operation:**
  - Grouped with a wall control: Luminaire will operate in vacancy mode (manual-on/auto-off)
  - Not grouped with a wall control: Luminaire will operate in occupancy mode (auto-on/auto-off)
- Luminaires operate at full intensity until OneButton™ Setup is initiated by the Cree Configuration Tool

### AMBIENT LIGHT SENSOR

- Sensor response matches response of human eye
- Not intended to be mounted higher than 12 ft. (3.7m)
- Luminaires operate at full intensity until OneButton™ Setup is initiated by the Cree Configuration Tool
- Daylight harvesting calibration performed automatically during OneButton™ Setup

### INTEGRAL WIRELESS COMMUNICATION

- 2.4GHz wireless mesh technology with AES 128-bit encryption
- Self assigns to quietest channel during OneButton™ Setup
- **Range:**
  - 30 ft. (9.1m) in typical commercial applications
  - 300 ft. (91.4) open air without obstructions
- **Network:** 250 devices max.
- **Space:** 100 devices max. per group
- FCC certified
- IC certified

### LUMINAIRE

- Luminaires operate at full intensity until OneButton™ Setup is initiated by the Cree Configuration Tool
- 10 year power fail memory of settings

### DEPLOYMENT

- Please refer to the SmartCast® Deployment Guide at [www.creelink.com/exLink.asp?236135640H88E44I39771048](http://www.creelink.com/exLink.asp?236135640H88E44I39771048)

## Motion and Ambient Light Sensor included with Cree SmartCast® Technology

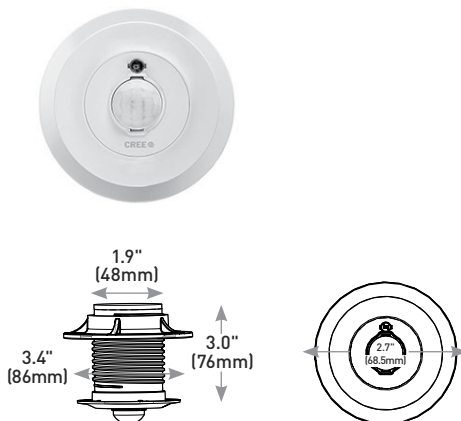

## Installation

- Recommended ceiling cutout 4.75" x 4.75" (120mm x 120mm)

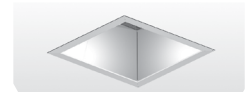

**Note:** 30L version requires marked spacing: 24" (600mm) x 12" (300mm) x 1/2" (12mm). 24" (600mm) luminaire to luminaire, 12" (300mm) luminaire to side wall, 1/2" (12mm) above luminaire

# KR4™ LED Specification Downlight with Cree SmartCast® Technology – Square 4"

## Photometry

### KR4S-30L-27K-120V W/KR4ST-SSGC-FF BASED ON RESTL REPORT TEST #: PL03922-001

Luminaire photometry has been conducted in accordance with IESNA LM-79-08. IESNA LM-79-08 specifies the entire luminaire as the source resulting in a luminaire efficiency of 100%.

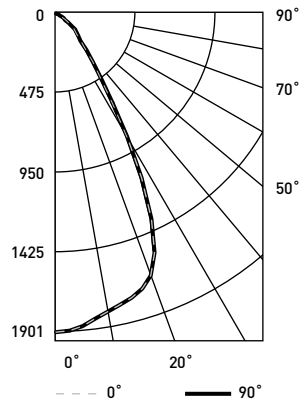

RESTL Test Report #: PL03922-001  
 KR4S-30L-27K-120V  
 w/KR4TS-SSGC-FF  
 Initial Delivered Lumens: 1,968  
 Efficacy: 51.0 LPW  
 S/M: 0.96

Coefficients Of Utilization – Zonal Cavity Method				
RC %:	80			
RW %:	70	50	30	10
RCR: 0	119	119	119	119
1	113	110	107	105
2	107	102	97	94
3	101	94	89	84
4	95	87	81	77
5	90	81	75	70
6	85	76	69	65
7	81	71	64	60
8	77	66	60	56
9	73	63	56	52
10	69	59	53	49

Effective Floor Cavity Reflectance: 20%

Average Luminance Table (cd/m <sup>2</sup> )			
Vertical Angle	Horizontal Angle		
	0°	45°	90°
45°	19,899	21,511	20,267
55°	12,253	9,386	12,426
65°	5,175	5,447	5,266
75°	1,861	2,925	1,891
85°	2,632	4,212	526

Zonal Lumen Summary			
Zone	Lumens	% Lamp	Luminaire
0-30	1,296	N/A	65.8%
0-40	1,691	N/A	85.8%
0-60	1,928	N/A	97.8%
0-90	1,971	N/A	100.0%
0-180	1,971	N/A	100.0%

Cone of Light		
Distance from Workplane	Footcandles	Beam Diameter
6' (1.8m)	53	5.7' (1.7m)
8' (2.4m)	30	7.6' (2.3m)
10' (3.0m)	19	9.6' (2.9m)
12' (3.7m)	13	11.5' (3.5m)
14' (4.3m)	10	13.2' (4.0m)

For exact photometric data, please reference our available IES and LM-79 test results at <http://lighting.cree.com/products/indoor/new-construction-downlights/kr-series>

## Application Reference

Based on KR4S-30L-27K-120V W/KR4TS-SSGC-FF Luminaire

Open Space					
Spacing	Lumens	Wattage	LPW	w/ft <sup>2</sup>	Average FC
4 x 4	2,050	39	53	2.34	128
6 x 6				1.09	60
8 x 8				0.59	31
10 x 10				0.39	21

10' Ceiling, 80/50/20 Reflectances, 2.5 workplane. LLF: 1.0 Initial. Open Space: 50' x 40' x 10'

Corridor					
Spacing	Lumens	Wattage	LPW	w/ft <sup>2</sup>	Average FC
4' on Center	2,050	39	53	1.63	54
6' on Center				1.04	35
8' on Center				0.78	26
10' on Center				0.65	21

10' Ceiling, 80/20/50 Reflectances, Light levels on the ground. LLF: 1.0 Initial. Corridor: 6' Wide x 100' Long

Recommended KR Series Lumen Maintenance Factors (LMF) <sup>1</sup>						
Ambient	Initial Delivered Lumens	Initial LMF	25K hr Projected <sup>2</sup> LMF	50K hr Projected <sup>2</sup> LMF	75K hr Calculated <sup>3</sup> LMF	100K hr Calculated <sup>3</sup> LMF
5°C (41°F)	9L and 13L	1.05	1.04	1.03	1.03	1.02
	20L and 30L	1.03	0.99	0.94	0.90	0.86
10°C (50°F)	9L and 13L	1.04	1.03	1.03	1.02	1.02
	20L and 30L	1.02	0.97	0.93	0.89	0.85
15°C (59°F)	9L and 13L	1.03	1.02	1.02	1.01	1.01
	20L and 30L	1.01	0.96	0.91	0.88	0.84
20°C (68°F)	9L and 13L	1.02	1.01	1.00	1.00	0.99
	20L and 30L	1.01	0.95	0.90	0.87	0.83
25°C (77°F)	9L and 13L	1.00	1.00	0.99	0.99	0.99
	20L and 30L	1.00	0.94	0.89	0.86	0.82
30°C (86°F)	9L and 13L	0.99	0.99	0.98	0.98	0.98
	20L and 30L	0.97	0.93	0.88	0.85	0.81
35°C (95°F)	9L and 13L	0.98	0.97	0.97	0.97	0.97
	20L and 30L	0.96	0.92	0.87	0.84	0.80
40°C (104°F)	9L and 13L	0.97	0.96	0.96	0.96	0.95
	20L and 30L	0.95	0.90	0.86	0.83	0.79

<sup>1</sup> Lumen maintenance values at 25°C (77°F) are calculated per TM-21 based on LM-80 data and in-situ luminaire testing

<sup>2</sup> In accordance with IESNA TM-21-11, Projected Values represent interpolated value based on time durations that are within six times (6X) the IESNA LM-80-08 total test duration (in hours) for the device under testing (DUT) i.e. the packaged LED chip

<sup>3</sup> In accordance with IESNA TM-21-11, Calculated Values represent time durations that exceed six times (6X) the IESNA LM-80-08 total test duration (in hours) for the device under testing (DUT) i.e. the packaged LED chip

